

# X-LITE™ recessed trimless

MOUNTING INSTRUCTIONS

## DO NOT DISCARD!

### SIGN LEGEND



POWER OFF



POWER ON



DO NOT TOUCH THE LED



ATTENTION



USE ESD GLOVES

### TOOLS REQUIRED (not included)



pencil



screwdriver



drill



screws



spackle knife



drywall saw

### X-Lite

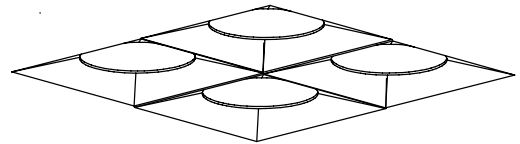

### X-LITE TRIMLESS

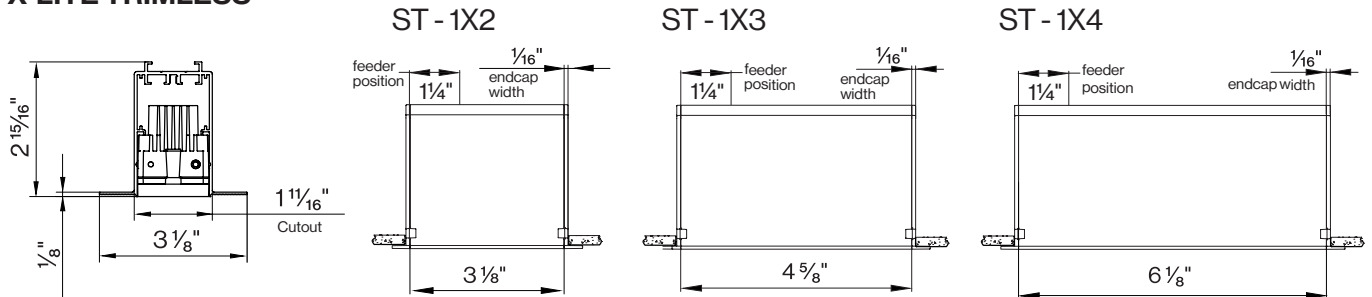

### SN-1X1

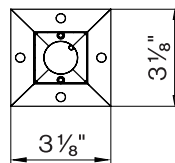
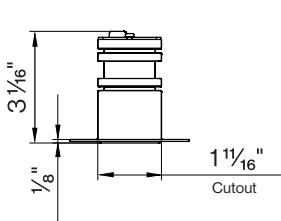

### SQ-2X2

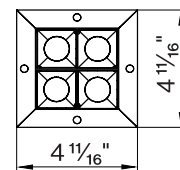
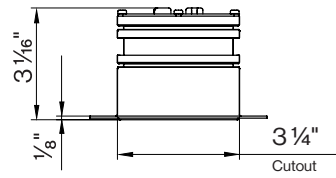



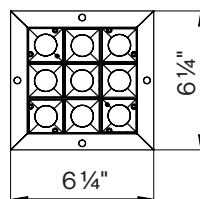
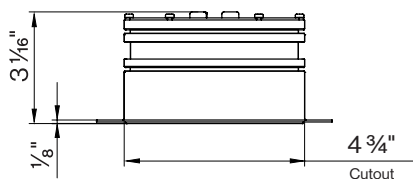



### SQ-3X3

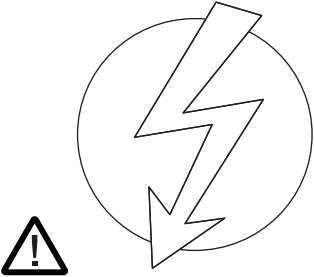
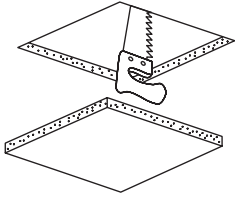

# X-LITE™ recessed trimless

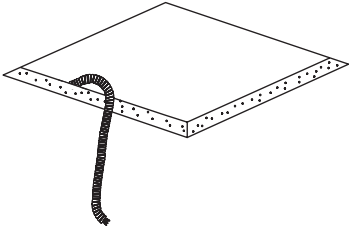
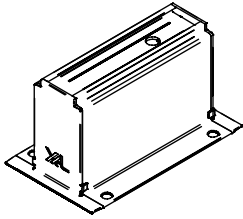
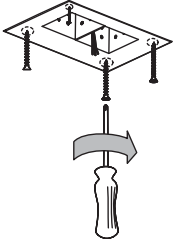
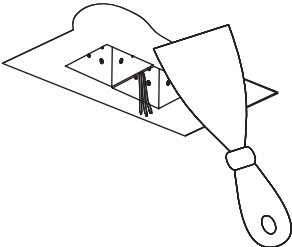
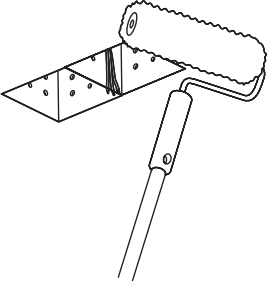
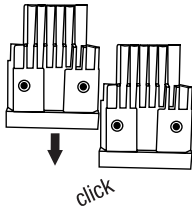
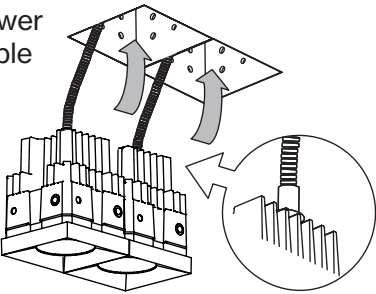
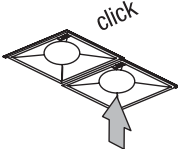
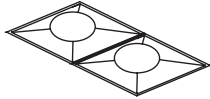
## MOUNTING INSTRUCTIONS

<p>TURN OFF POWER SOURCE BEFORE INSTALLATION</p> 	<p>1. Cut out hole in ceiling</p>  <p>*cutout dimension above</p> 	<p>2. Insert blocking into ceiling (supplied by others)</p>  
<p>3. Flex conduit supplied by others</p> 	<p>4. Lift housing to ceiling</p> 	<p>5. Screw fixture to ceiling</p> 
<p>6. Spackle the ceiling around the cutout hole</p> 	<p>7. Paint the ceiling</p> 	<p>8. <b>OPTIONAL:</b> Configurations (see page 1 for different housing options) Slide and click each peice together</p>  <p>click</p>
<p>9. Connect power cable</p> 	<p>10. "Click in" the lamps</p>  <p>click</p>	<p>11. Installation complete</p>   should hear "click" once secure

# X-LITE™ recessed trim







MOUNTING INSTRUCTIONS

## DO NOT DISCARD!

### SIGN LEGEND

-  POWER OFF
-  POWER ON
-  DO NOT TOUCH THE LED
-  ATTENTION
-  use ESD gloves

### TOOLS REQUIRED (not included)

-  pencil
-  screwdriver
-  screws
-  drill
-  spackle knife
-  drywall saw

### X-LITE TRIM

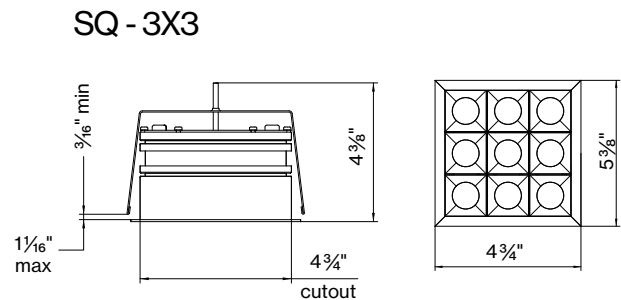
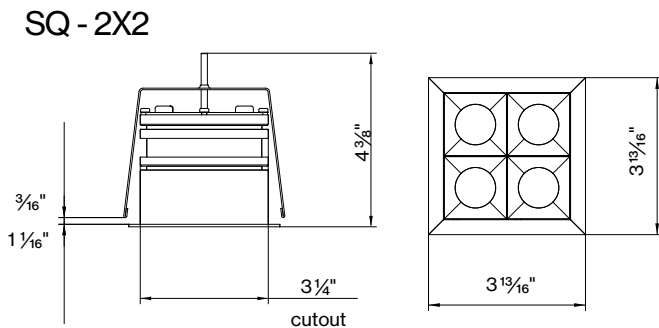
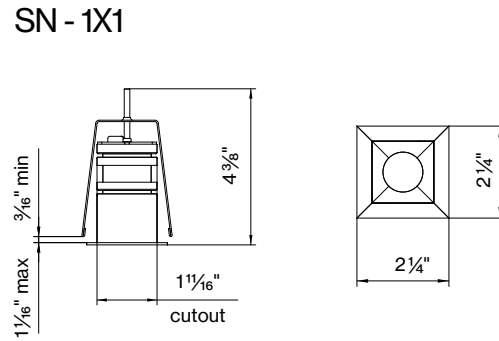
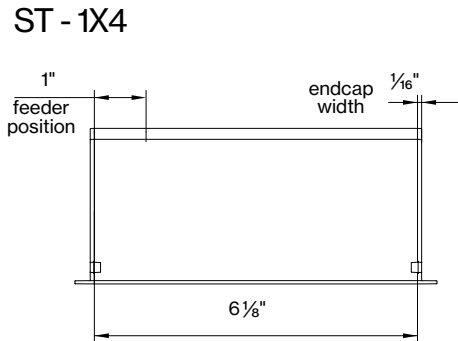
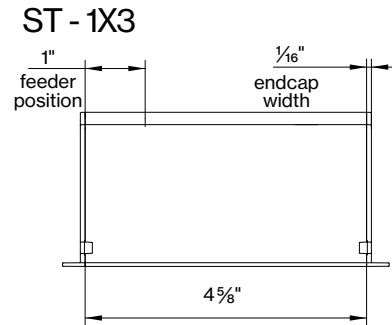
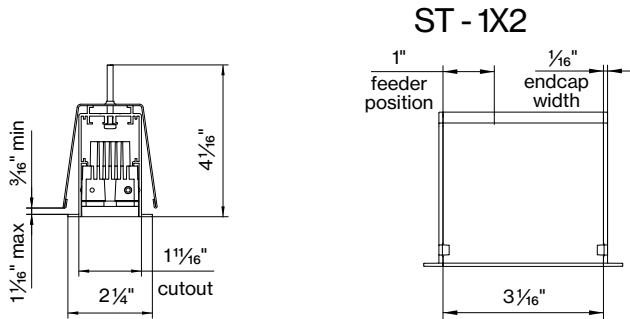
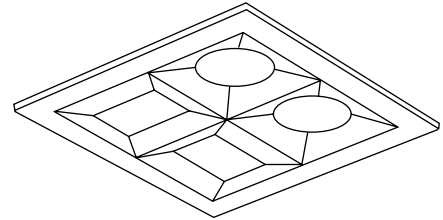

# X-LITE™ recessed trim

## MOUNTING INSTRUCTIONS

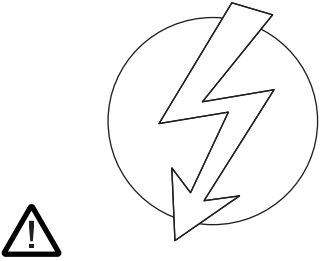
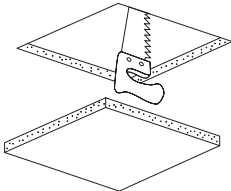
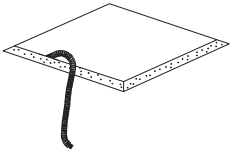
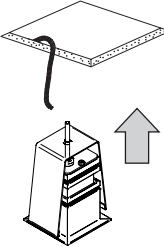
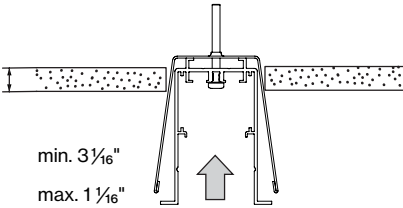
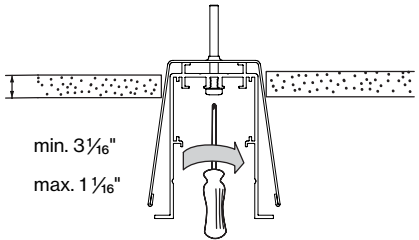
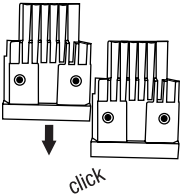
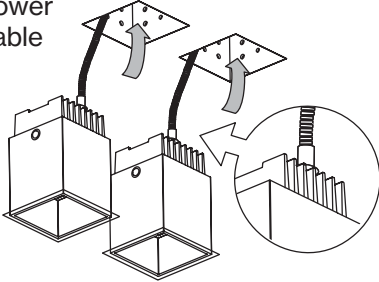
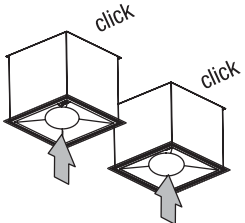
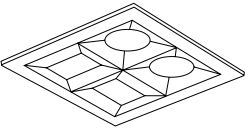
<p>TURN OFF POWER SOURCE BEFORE INSTALLATION</p> 	<p>1. Cut out hole in ceiling</p> 	<p>2. Flex conduit supplied by others</p> 
<p>3. Thread conduit through top of channel (conduit supplied by others)</p> 	<p>4. Insert channel into ceiling.</p> 	<p>5. Turn screw(s) clockwise to secure bracket(s). Repeat steps for additional channels</p> 
<p>6. Optional: Configurations: (see above for different housing options) Slide and click each piece together</p> 	<p>7. Connect power cable</p> 	<p>8. "Click in" the lamps</p> 
<p>9. Installation complete</p> 		

### Technical Support Hotline

Call the Technical Support Hotline from  
Monday to Friday, 8 AM - 6 PM (EST)

Hotline:  
**+1 203 262 9990**

Or 24/7 via email:  
**service@xalusa.com**

**EN** Installation, commissioning and maintenance may only be performed by authorized and qualified personnel, taking into consideration these installation instructions and any standards and regulations applicable to the respective area of application. The electrical, mechanical and thermal suitability of the luminaire for the intended area of application must be ensured and the secure fastening of the luminaire after its installation must be controlled. Turn off supply voltage before replacing any lamps (if applicable) as well as before performing any other works on the luminaire (e.g. cleaning) and wait until luminaire and lamp have completely cooled off. Please refer to the installation notes of the lamp manufacturer when inserting, replacing and operating conventional lamps. Use a soft, damp cloth to clean the luminaire. To clean plastic components and reflectors, a standard pH neutral, alcohol-free, non-abrasive cleaning agent may also be used. Keep these installation instructions in a safe place as reference for any future maintenance works.

1. The lamp is not suitable for outdoor use.
2. The lamp may only be used with a safety guard.
3. Damaged protection glasses and covers have to be replaced immediately.
4. Corrosive chemical products must not be used as this may have a detrimental effect on the luminaire.
5. No liability is accepted for any subsequent change of the luminaire.
6. LEDs are high-quality electronic components! Please avoid touching by hand the LED light emitting surface while assembling or replacing parts and during maintenance work.
7. To avoid damage of the profile, unevenness on the wall or ceiling must be leveled out before assembling the profiles. While assembling the profiles, make sure they do not deform in order to guarantee their proper function.
8. The light source contained in this luminaire shall only be replaced by the manufacturer or his service agent or a similar qualified person.
9. The LED circuit must always be closed, before the converter is connected to the main power. XAL does not assume any liability for damages resulting from nonobservance of this rule.
10. Luminous flux and connected electrical load are subject to an initial tolerance of up to +/- 10%. Color temperature is subject to a tolerance of up to +/- 150 Kelvin from the nominal value.

**FR** Le montage et la maintenance peut être effectué par spécialistes respectant les normes y régles valides. Assurer l'aptitude thermique, mécanique et électrique pour l'emploi prévue et assurer la fixation de la luminaire. Éteindre la tension avant de changer les lampes (si applicable) ou avant de réaliser travaux (p.ex nettoyage) à la luminaire. Attendre jusqu'à ce que la luminaire et les lampes ont fraîchit complètement. Merci de bien vouloir vous référer aux notes d'installation du fabricant de la lampe lors de l'insertion, le remplacement et la mise en route, avec des lampes conventionnelles. Pour nettoyer la luminaire utiliser un drap humide et doux. Pour nettoyer les parties du plastique ou les réflecteurs on peut utiliser encore un produit de nettoyage sans alcool qui ne fraye pas le material. Garder cette notice de montage pour possibles travaux de maintenance.

1. La luminaire n'est pas apte pour l'utilizage exterieur.
2. Utilizer la luminaire seulement avec un dispositif de sécurité
3. Changer immédiatement des verres de sécurité defectes ou bien des écrans de protection.
4. Evitez tout contact de la lampe avec de produits chimiques corrosifs.
5. Nous déclinons toute responsabilité en cas de modifications ultérieures.
6. Des LEDs sont des composants électroniques de haute qualité! Eviter tout contact direct de la surface de sorti de lumière de la LED avec les mains lors du montage ou des les travaux de maintenance de la lampe.
7. Pour éviter l'endommagement du profil, il est nécessaire de compenser les irrégularités du mur ou du plafond avant le montage des profils. Pour garantir un fonctionnement irréprochable des profils, il ne faut pas déformer les profils lors du montage.
8. La source du luminaire peut être remplacé uniquement par le fabricant ou un tiers habilité.
9. Il faut que le circuit de LED soit fermé avant de connecter le convertisseur. XAL ne assume pas la garantie si cette norme ne se respecte pas.
10. La puissance et le flux lumineux affichent d'origine une tolérance de +/-10 %. Tolérance de la couleur de température : +/- 150 Kelvin.

**ES** La instalación, la puesta en marcha y el mantenimiento sólo deben realizarse por personal especializado considerando esta guía de instalación y todas las normas y reglamentaciones vigentes. Asegurarse de la aptitud eléctrica, mecánica y térmica de la luminaria para la aplicación prevista y comprobar la fijación segura de la luminaria después de su instalación. Apagar siempre la corriente antes de cambiar la lámpara (en caso justificado) o de realizar algún otro trabajo en esta (p.ej. Limpieza). Esperar hasta que se enfrién la luminaria y la lámpara completamente. Tener en cuenta las instrucciones de montaje del fabricante al colocar, cambiar y utilizar lámparas convencionales. Para la limpieza de la luminaria utilizar un paño suave y húmedo. Para limpiar componentes de plástico y reflectores puede usar también un limpiador pH neutral y sin alcohol que no roce el material. Guardar esta guía de instalación para trabajos de mantenimiento.

1. La luminaria no es apta para utilizarla en el exterior.
2. La luminaria sólo debe accionar con un dispositivo de seguridad.
3. Cambie de inmediato los vidrios y las tapas de protección dañados.
4. Químicos que tienen efectos corrosivos no deben influir en la luminaria.
5. Para modificaciones futuras en la luminaria no se asume ninguna responsabilidad.
6. Los LED son componentes electrónicos de alta calidad! Por favor durante el montaje o el mantenimiento evite el contacto directo con la superficie de emisión.
7. Para evitar daños en el perfil, los desniveles de las paredes y techos deben ser enrasados antes del montaje de los perfiles. Para garantizar su buen funcionamiento, los perfiles no deben sufrir deformaciones durante el montaje.
8. La fuente luminosa contenida en esta luminaria debe ser reemplazada únicamente por el fabricante o su agente de servicio o similar persona cualificada.
9. El circuito LED debe ser cerrado antes de conectar el convertidor. XAL no asume garantía si esta norma no se respeta.
10. I dati di flusso luminoso e potenza sono inizialmente passibili di tolleranze di +/- 10%. Tolleranza della temperatura di colore: +/- 150 Kelvin.

We reserve the right to change our products at any time. Current information is available at [www.xalusa.com](http://www.xalusa.com).

Nos reservamos en todo momento el derecho de realizar cambios en nuestros productos. n nuestra página web [www.xalusa.com](http://www.xalusa.com) siempre se encontrarán datos actuales.

Nous nous réservons le droit de modifier à tout moment nos produits. Vous trouverez toujours toutes les informations actuelles sur [www.xalusa.com](http://www.xalusa.com).

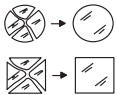

The lamp may only be operated with its full protective cover!

L'apparechio necessita del relativo vetro di protezione!

Sólo usar la luminaria con su cobertura de seguridad completa!

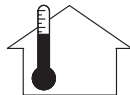

Recommended room temperature: 77 °F.  
Temperatura ambiente recomendada: 77 °F.  
Température ambiante recommandée: 77 °F.



**Don't touch the LED**



Use gloves.  
Use guantes.  
Utiliser des gants.