

X-LITE™

DIRECT

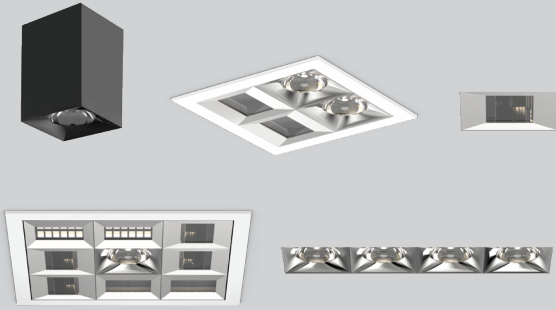

CERTIFICATIONS & COMPLIANCE



FEATURES



PERFORMANCE

- Up to 70 lm/W
- Multipurpose lighting system
- Multiple lens and housing options
- Recessed, surface, suspended

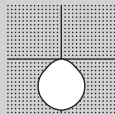

HOUSING OPTIONS

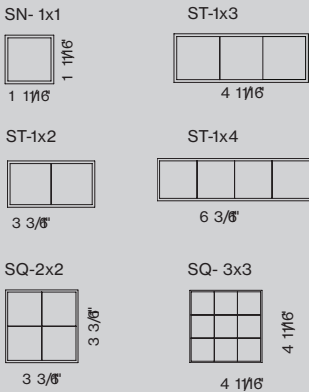

SIDE VIEW

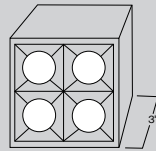

*HEIGHT IS 3" FOR ALL MOUNTING TYPES

DIMENSIONS

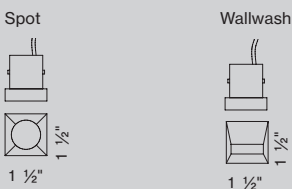

Specification/Instructions

Use the drop downs to select each cells attribute.

1. Select mounting type, housing color, color temperature, and cell color
2. Select Dim config for cell formation
3. Cell attribute will auto fill depending on selection made for each cell.

Mounting

Housing Color

Color temp

Cell Color

Cell 1	Cell 2
Lens <input type="text"/>	Lens <input type="text"/>
DIM Config. <input type="text"/>	DIM Config. <input type="text"/>
NOTES <input type="text"/>	NOTES <input type="text"/>

Cell 3	Cell 4
Lens <input type="text"/>	Lens <input type="text"/>
DIM Config. <input type="text"/>	DIM Config. <input type="text"/>
NOTES <input type="text"/>	NOTES <input type="text"/>

Dim Config

A		B	
1	1	1	2
1	1	1	2

C		D		E	
1	2	1	2	1	2
2	1	3	1	3	4

Attributes Key

Use the housing and cell attributes key.

Dim Config

1	2
3	4

Housing Attributes Key		Cell Attributes Key	
A RANGE	XLITE	A CELL TRIM COLOR	B G
B PATTERN	Single 1x1 Straight 1x2 Straight 1x3 Straight 1x4 Square 2x2 Square 3x3	Black Gloss Black Matte Chrome White Gloss White Matte	B M C H W G W M
C MOUNTING	Recessed Trimless Recessed Trim Surface Mounted Pendant	D CELL LENS	Spot 14 deg Medium 24 deg Flood 36 deg Wide 60 deg Wall Wash Up Wall Wash Down Wall Wash Left Wall Wash Right Blind Cover
D HOUSING COLOR	White Black Gray	E CELL DIMMING CHANNEL	Channel 1 Channel 2 Channel 3 Channel 4
E DIMMING CHANNEL	single channel dual channel three channel four channel	F CELL COLOR TEMPERATURE	2700K CRI90 3000K CRI 90 3500K CRI 90 4000K CRI 90
	*RTL in white only		

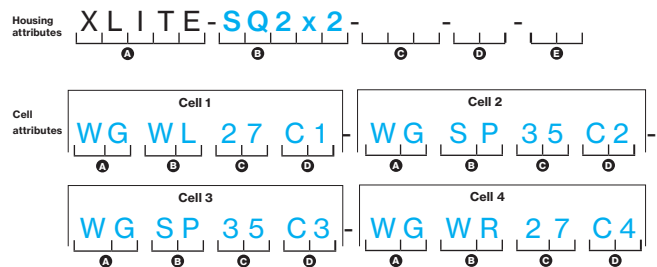
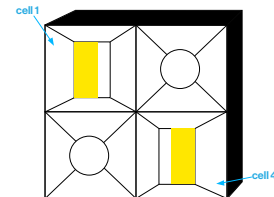

Diagram Example

TOP ROW: Cells 1-2
Cell 1: White Gloss cell color, Wall Wash, light shinning left, and 2700K CRI90 temp.
Cell 2: White Gloss, Spotlight, 3500K CRI 90 temp.

SECOND ROW: Cells 3-4
Cell 3: White Gloss, Spotlight, 3500K CRI 90 temp.
Cell 4: White Gloss cell color, Wall Wash, light shinning right, and 2700K CRI 90 temp.



X-LITE™

ST 1X3

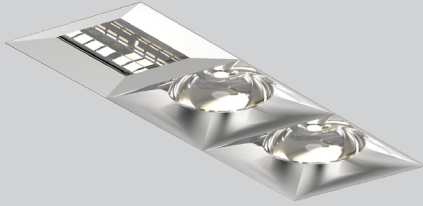

CERTIFICATIONS & COMPLIANCE



FEATURES



PERFORMANCE

- Up to 70lm/W efficiency
- Multiple lens options
- Recessed, surface & pendant
- CRI > 90

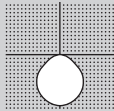

DIAGRAM

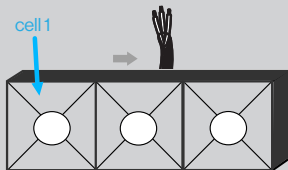

*Spot and Wallwash cells must have separate dimming channels.

SINGLE CELL LIGHT DISTRIBUTIONS

SPOT LENS 14°

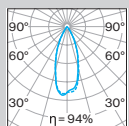

C0 C18 0
C90 C270
LED array 2.3W / 245lm
106 lm/W

MEDIUM LENS 30°

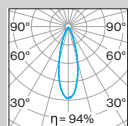

C0 C18 0
C90 C270
LED array 2.3W / 225lm
98 lm/W

FLOOD LENS 36°

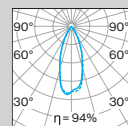

C0 C18 0
C90 C270
LED array 2.3W / 235lm
101 lm/W

WIDE LENS 57°

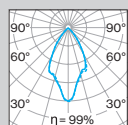

C0 C18 0
C90 C270
LED array 2.3W / 215lm
93 lm/W

WALL WASH

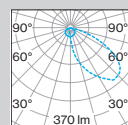

C0 C18 0
C90 C270
LED array 4.9 W / 365lm
75 lm/W

MOUNTING

HOUSING COLOR

*RTL in white only

COLOR TEMP

CELL COLOR

DIM CONFIG.

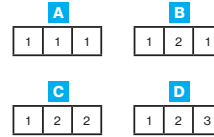

Cell 1	Cell 2	Cell 3
LENS <input type="text"/>	LENS <input type="text"/>	LENS <input type="text"/>
DIM CONFIG. <input type="text"/>	DIM CONFIG. <input type="text"/>	DIM CONFIG. <input type="text"/>
NOTES <input type="text"/>	NOTES <input type="text"/>	NOTES <input type="text"/>

Housing attributes **XLITE-ST1x3-**

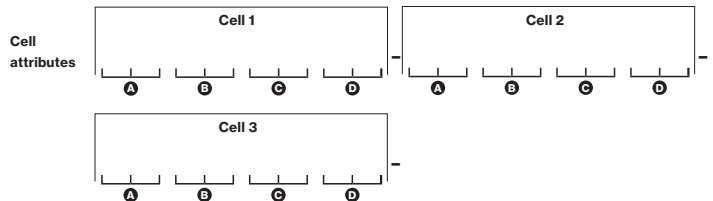

Housing Configuration Code
XLITES30 00

Cell Configuration Code
XCS3 00 0

BASO
basolighting.com

Power supply

1. LINE CONTROL

X-LITE 0-10V POWER SUPPLIES

	SPOT CELLS	WALLWASH CELLS
1 cell	XLPS - 12 - SP - 001	XLPS - 12 - WW - 001
2 cell	XLPS - 12 - SP - 002	XLPS - 12 - WW - 002
3 cell	XLPS - 12 - SP - 003	XLPS - 12 - WW - 003
4 cell	XLPS - 12 - SP - 004	XLPS - 12 - WW - 004
5 cell	XLPS - 12 - SP - 005	XLPS - 12 - WW - 005
6 cell	XLPS - 12 - SP - 006	XLPS - 12 - WW - 006
7 cell	XLPS - 12 - SP - 007	XLPS - 12 - WW - 007
8 cell	XLPS - 12 - SP - 008	XLPS - 12 - WW - 008
9 cell	XLPS - 12 - SP - 009	XLPS - 12 - WW - 009

*X-Lite configurations with both Spot and Wallwash cells will need two separate remote drivers

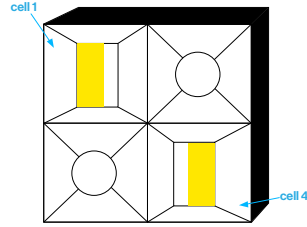

Wiring diagrams

1. LINE CONTROL

0-10V DIM Single Circuit

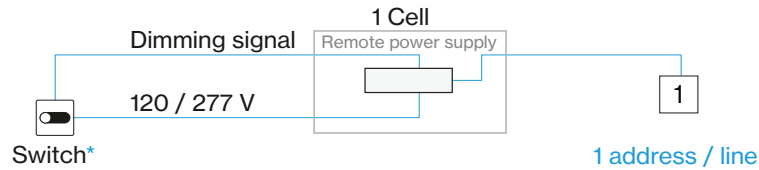

0-10V DIM Dual Circuit

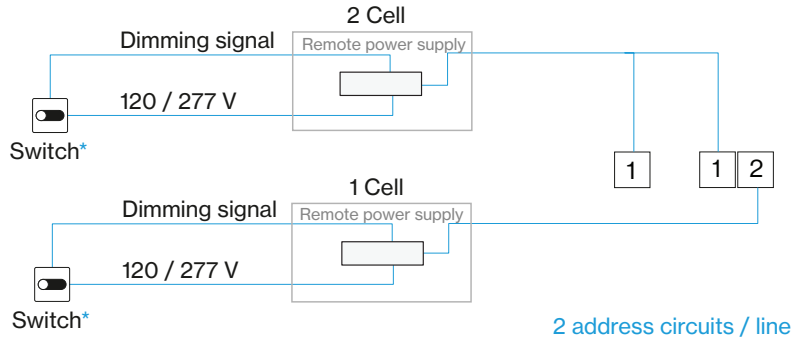

0-10V DIM Tri Circuit

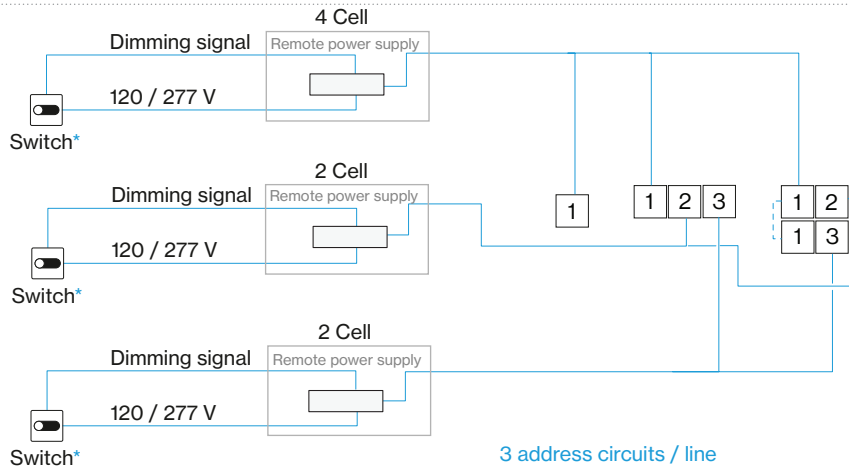

Wiring diagrams continued

0-10V DIM Quad Cir cuit

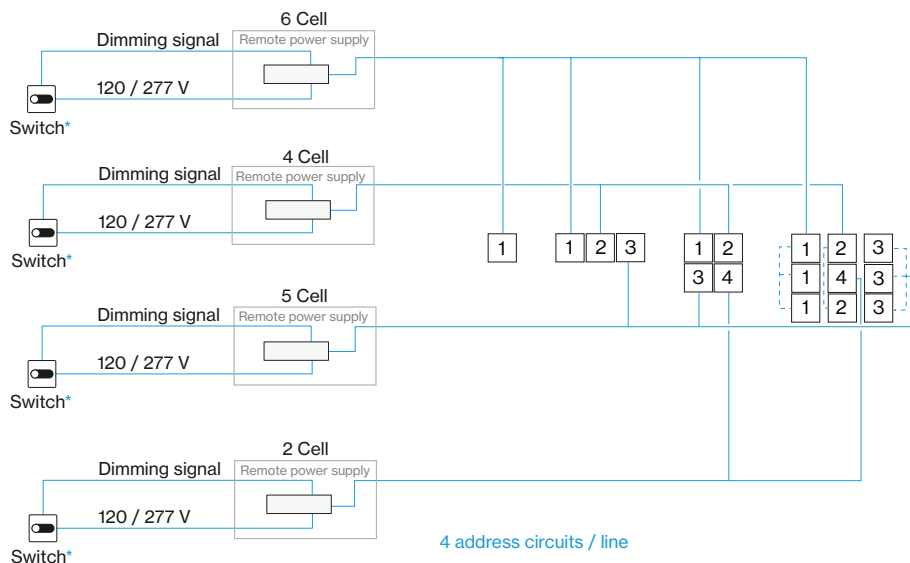

Length range per power supply

POWER SUPPLY

Length A max 150'

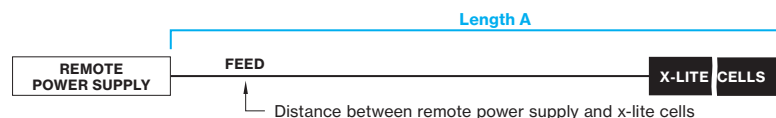

Declare.

**X-LITE
BASO Inc.**

Final Assembly: Oxford, Connecticut, USA
 Life Expectancy: 7 Year(s)
 End of Life Options: Recyclable (80%), Landfill (20%)

Ingredients:

Steel, manufacture, chemicals, Aluminum, Small electrical component, Poly(vinyl chloride), Copper chloride (CuCl₂), Poly(ethylene terephthalate), hexanediyl(mono-1,6-hexanediyl)

^LBC Temp Exception RL-002 - Small Electrical Components

Living Building Challenge Criteria:

H3 Red List:

- LBC Red List Free
- LBC Red List Approved
- Declared

H10 Interior Performance: Not Applicable
H14 Responsible Sourcing: Not Applicable

BAS-0003
 EXP: 01 JUL 2025
 Original Issue Date: 2024

INTERNATIONAL LIVING FUTURE INSTITUTE™ livingfuture.org/declare

Mounting instructions

Get access to the mounting instructions faster by scanning the QR code.

<https://www.basolighting.com/resources/mounting-instructions/x-lite>

