

M-LINE

DIRECT/INDIRECT



CERTIFICATIONS & COMPLIANCE



FEATURES



PERFORMANCE

- 48V low voltage track
- Multiple inset options
- CRI > 90
- Flexible magnetic profile system

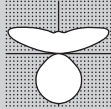

MOUNTING

M-LINE 1.1

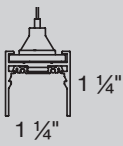

M-LINE 1.2

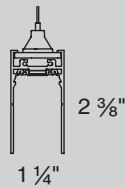

PATTERNS



*X Shapes Angular Curves Rectangular *T Shapes *Wall to Ceiling

For customization, please contact customer service

MAGNETIC ATTACHMENT

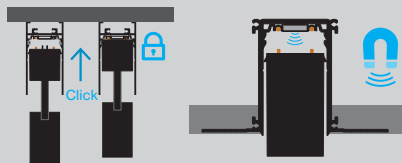

Catalog Number Example

MLTR1.1-PDT-BL-BW-30K-C90-48V-010V-500LF-LS-02FT

A B C D E F G H I J K

A RANGE

M-LINE 1.1	MLTR 1 . 1
M-LINE 1.2	MLTR 1 . 2

B MOUNTING

QS Pendant	PDT
pendant suspension set includes cable suspension and one white J-box cover	

C COLOR

White	WH
QS Black	BL

D INDIRECT LENS

Batwing uplight	BW
-----------------	----

E CCT

2700 K	2 7 K
3000 K	3 0 K
3500 K	3 5 K
4000 K	4 0 K

F CRI

CRI > 90	C 9 0
----------	-------

G VOLTAGE

48V	4 8 V
constant voltage track	

H DIMMING

QS 0-10V 1% single control	0 1 0 V
0-10V 1% dual control*	DC 1 0

*two 0-10V dimming outputs

wiring diagram is on power supply page

I OUTPUT LM/FT INDIRECT

500lm/ft †	0 5 0 0 L F
------------	-------------

J SHAPE / PATTERN

QS Linear	ST
L-shape	LS
□-shape (rectangular shape)	RS
U-shape	US
Z-shape	ZS
Wall to ceiling	WC
Custom shape	XX

for more patterns, please consult customer service (RCP required)

K DIMENSIONS IN FEET

Linear 2'	0 2 FT
QS Linear 4'	0 4 FT
Linear 6'	0 6 FT
QS Linear 8'	0 8 FT
Linear custom	# # FT
L-shape custom	# # X # # FT
□-shape custom	# # X # # FT
U-shape custom	# # X # # X # # FT
Z-shape custom	# # X # # X # # FT

dimensions starting at 2' in 1' increments; for custom dimensions, please consult customer service; track not field-cuttable

Accessories

BLIND COVER (field cuttable)		
LENGTH FT/INCH		1 1/2"
4'	black	N 5 0 - 4 0 0 4 0 0 8
8'	black	N 5 0 - 4 0 0 8 0 0 8

M-LINE channel dimensions

M-LINE 1.1

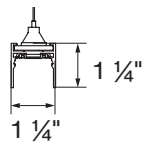

M-LINE 1.2

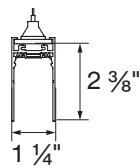

Channel

UPLIGHT direct / batwing upright / 5.5W/ft / 27K / 30K / 35K

PROFILE LENGTH	UPLIGHT LENGTH	INPUT WATTS	DELIVERED LUMENS
2'	1 1/2'	8 W	1000 lm
4'	3 1/2'	16 W	2000 lm

Possible shapes top view please provide RCP to ensure correct shape orientation

LINEAR

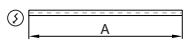

L-SHAPE

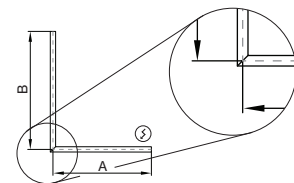

Z-SHAPE

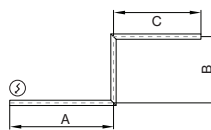

□-SHAPE

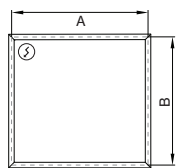

U-SHAPE

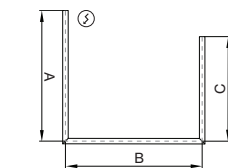

WALL TO CEILING

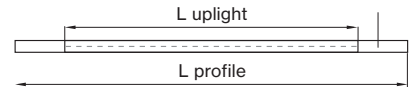
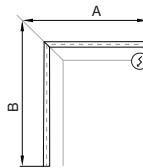

Power feeder locations

POWER FEED

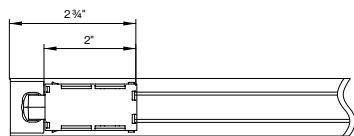

CORNER POWER COUPLER

SINGLE CONTROL (010V)

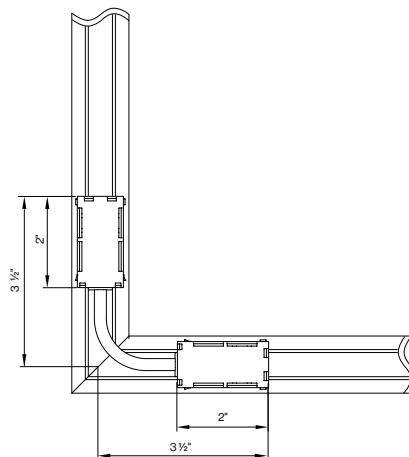

DUAL CONTROL (DC10)

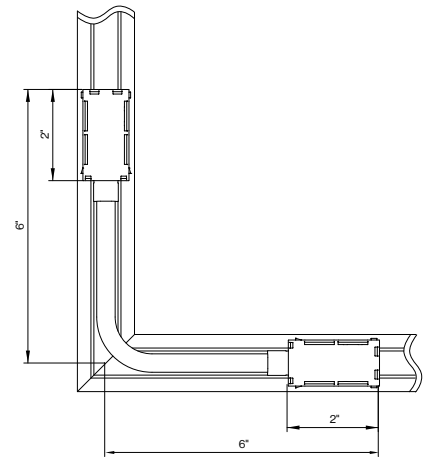

LINEAR POWER COUPLER

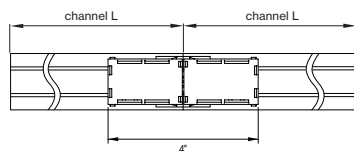

M-LINE Mounting Instructions

Get access to the M-LINE mounting instructions faster by scanning the QR code.

<https://www.basolighting.com/resources/mounting-instructions/m-line>

