

BASO 4.0 DIRECT

Catalog Number Example

BASO 4.0-SAT-BL-OP-30K-C80-UNV-010V-0500LF-ST-24IN

A B C D E F G H J L N

CERTIFICATIONS & COMPLIANCE



FEATURES



PERFORMANCE

- Up to 111lm/W efficiency
- 500 / 955 lm/ft
- CRI > 80 & CRI > 90
- Damp rated

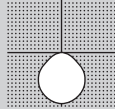

MOUNTING

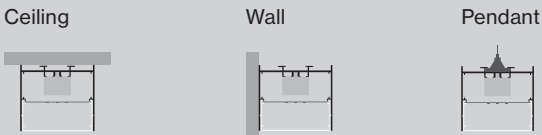

PATTERNS

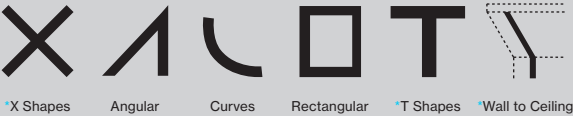

For customization, please contact customer service

FIELD-CUTTABLE FLEX

Down to 1/16"



[link to video](#)

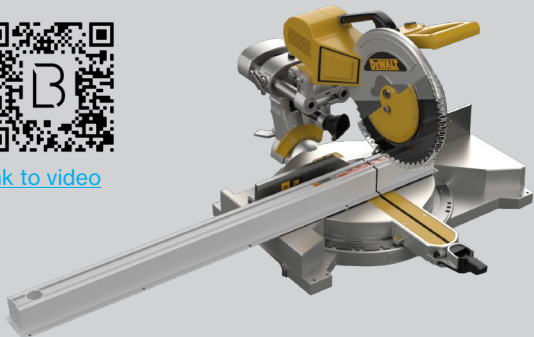

A RANGE

BASO 4.0 BASO4 . 0

B MOUNTING

QS Surface	SUR
Surface in-line ACT T-BAR	SAT
Surface in-line ACT SLOT	SAS
Surface ACT center tile	SAC
QS Pendant	PDT
Pendant in-line ACT T-BAR	PAT
Pendant in-line ACT SLOT	PAS
Pendant ACT center tile	PAC

pendant suspension set includes cable suspension and one white power feeder with a white junction box cover

Wall mounted WAL

for black power feeds or junction box covers, please contact customer service

C COLOR

QS White	WH
QS Black	BL
Gray	GR
Custom color RAL	XX

trimless version available in white only

D LENS

HP opal cover OP

E CCT

2700K	27K
QS 3000K	30K
QS 3500K	35K
4000K	40K

F CRI

CRI > 80	C80
CRI > 90	C90

G VOLTAGE

120V/277V UNV

H DIMMING

QS 0-10V 1%	010V
Lutron EcoSystem	LES1
Quantum, Vive, GRAFIK Eye, HomeWorks	
Power over ethernet	POEC
consult customer service for compatibility	
Custom dimming	XXXX
consult customer service for compatibility	

I SENSOR (optional)

Integrated Sensor SEN
consult customer service for sensor request

J OUTPUT LM/FT

QS 500 lm/ft 100% ↓	0500LF
QS 750 lm/ft 100% ↓	0750LF
QS 1000 lm/ft 100% ↓	1000LF
Custom lm/ft	XXXXLF

custom lumen up to 1400 lm/ft

K CIRCUIT / EM

QS Single circuit	*
EMC night light circuit	NLC
EMB available in 4ft and 8ft	EM#

* leave blank

L SHAPE / PATTERN

QS Linear / straight	ST
QS Linear / straight + flex inset	SF

includes 1ft. field-cutttable section; only available for 4' and 8' segments

L-shape	LS
□-shape (rectangular shape)	RS
U-shape	US
Custom shape	XX

M DIMENSIONS IN INCH

Linear 2'	24IN
QS Linear 4'	48IN
QS Linear 6'	72IN
QS Linear 8'	96IN
Linear custom	###IN
Linear flex inset	###IN

includes 4' to 3' field-cutttable section



L-Shape	###X###IN
U-Shape	###X###X###IN
□-Shape	###X###IN

for lengths including flex insets, round up to the nearest total foot length

N CERTIFICATION (optional)

Red List Approved RLA

Technical data

	SIZE TYPE	LED COLOR TEMPERATURE	INPUT WATTS	DELIVERED LM TOTAL	LIGHT DISTRIBUTION	DELIVERED LM DIRECT	DELIVERED LM INDIRECT	OPTICAL EFFICIENCY	LUMINAIRE EFFICACY	
BASO DIRECT										
	e LED	2' linear	40K	9W	910lm	100% down	500lm/ft	-	76%	111lm/W
		4' linear		18W	2000lm					
		6' linear		27W	3000lm					
		8' linear		36W	4000lm					
		2' + 2' corner		18W	2000lm					
	e ² LED	2' linear	40K	18W	1920lm	100% down	955lm/ft	-	76%	106lm/W
		4' linear		36W	3840lm					
		6' linear		54W	5730lm					
		8' linear		72W	7680lm					
		2' + 2' corner		36W	3840lm					

for 30 K or 35 K multiply lm value by 0.96

Patterns top view

LINEAR

A	FIXTURES	CODE
48"	1 × 4' linear	ST - 0 4 FT
96"	1 × 8' linear	ST - 0 8 FT
144"	3 × 4' linear	ST - 1 2 FT

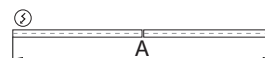

L-SHAPE

A / B	FIXTURES	CODE
48" / 48"	2 × 2' linear + 1 × 2' × 2' corner	LS - 0 4 X 0 4 FT
48" / 96"	1 × 2' linear + 1 × 6' linear + 1 × 2' × 2' corner	LS - 0 4 X 0 8 FT
96" / 96"	2 × 6' linear + 1 × 2' × 2' corner	LS - 0 8 X 0 8 FT

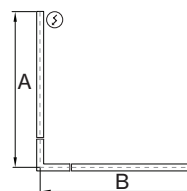

□-SHAPE (rectangular shape)

A / B	FIXTURES	CODE
48" / 48"	4 × 2' × 2' corner	RS - 0 4 X 0 4 FT
48" / 96"	2 × 4' linear + 4 × 2' × 2' corner	RS - 0 4 X 0 8 FT
96" / 96"	4 × 4' linear + 4 × 2' × 2' corner	RS - 0 8 X 0 8 FT

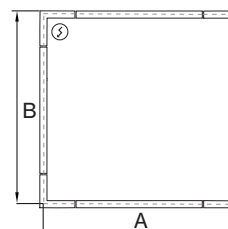

U-SHAPE

A / B / C	FIXTURES	CODE
48" / 48" / 48"	2 × 2' linear + 2 × 2' × 2' corner	US - 0 4 X 0 4 X 0 4 FT
48" / 96" / 48"	1 × 4' linear + 2 × 2' linear + 2 × 2' × 2' corner	US - 0 4 X 0 8 X 0 4 FT
48" / 144" / 48"	1 × 8' linear + 2 × 2' linear + 2 × 2' × 2' corner	US - 0 4 X 1 2 X 0 4 FT

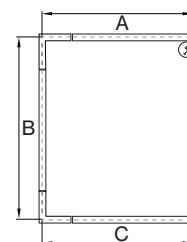

DIMENSIONS

BASO 4.0

SURFACE direct

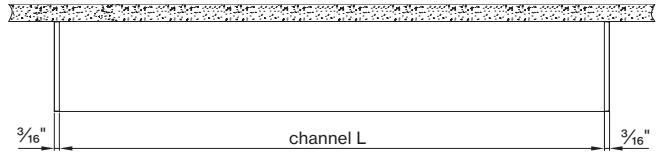
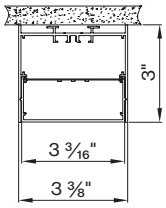

PENDANT

direct

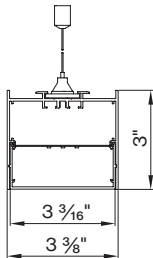

direct / indirect

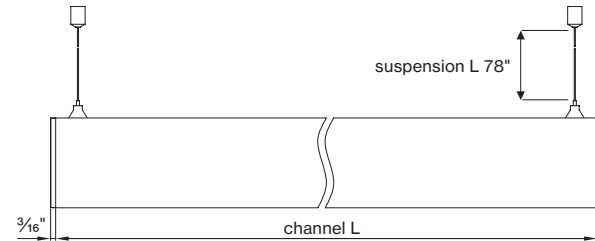
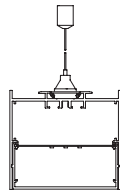

BASO 4.0 SPECIALITY MOUNTING

SURFACE
in-line ACT TBAR

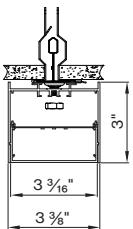

SURFACE
in-line ACT SLOT

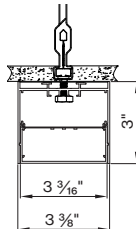

SURFACE
ACT center tile

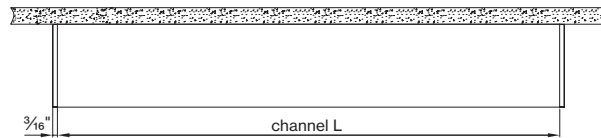
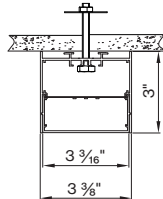

PENDANT
ACT TBAR

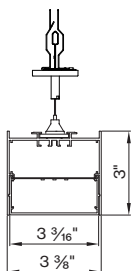

PENDANT
in-line ACT SLOT

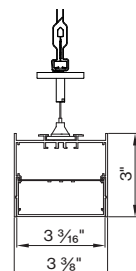

PENDANT
ACT center tile

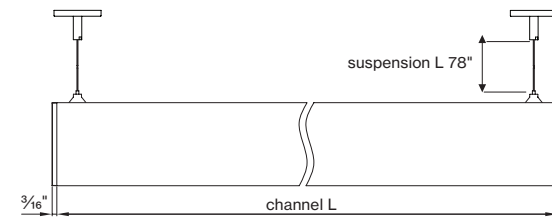
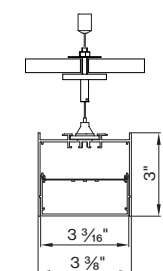

BASO mounting instructions

Get access to the BASO 4.0 mounting instructions faster by scanning the QR code.

<https://www.basolighting.com/resources/mounting-instructions/baso>

