

BASO 2.5

DIRECT/INDIRECT

Catalog Number Example

BASO 2.5-PDT-BL-OPBW-27K-C80-UNV-010V-0500LF-0500LF-DC-ST-48IN

A B C D E F G H J K L M N

CERTIFICATIONS & COMPLIANCE



FEATURES



PERFORMANCE

- Up to 112lm/W efficiency
- 455 / 750lm/ft
- CRI > 80 & CRI > 90
- Damp rated

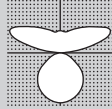

MOUNTING

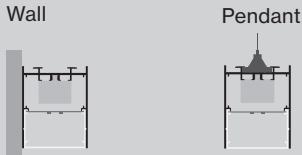

PATTERNS

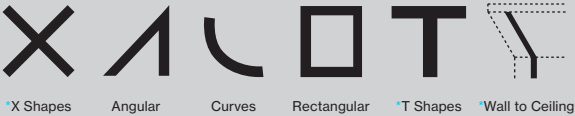

For customization, please contact customer service

FIELD-CUTTABLE FLEX

Down to 1/16"



[link to video](#)

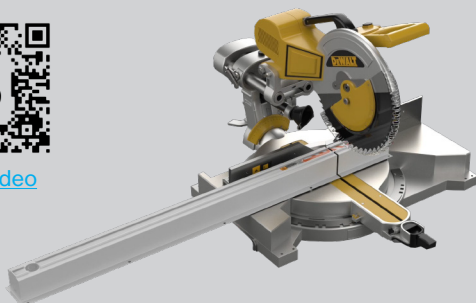

A RANGE

BASO 2.5 BASO 2.5

B MOUNTING

Pendant P D T
 Pendant in-line ACT T-BAR P A T
 Pendant in-line ACT SLOT P A S
 Pendant ACT center tile P A C
 pendant suspension set includes cable suspension and one white power feeder with a white junction box cover
 Wall mounted W A L

for black power feeds or junction box covers, please contact customer service

C COLOR

White W H
 Black B L
 Gray G R
 Custom color RAL X X

trimless version available in white only

D LENS

HP opal cover direct O P B W
 batwing cover indirect

E CCT

2700K 2 7 K
 3000K 3 0 K
 3500K 3 5 K
 4000K 4 0 K

F CRI

CRI > 80 C 8 0
 CRI > 90 C 9 0

G VOLTAGE

120V / 277V U N V

H DIMMING

0-10V 1% 0 1 0 V
 Lutron EcoSystem L E S 1
 Quantum, Vive, GRAFIK Eye, HomeWorks
 Power over ethernet P O E C
 consult customer service for compatibility
 Custom dimming X X X X
 consult customer service for compatibility

I SENSOR (optional)

Integrated Sensor S E N
 consult customer service for sensor request

J OUTPUT LM/FT DOWN

500lm/ft 100% ↓ 0 5 0 0 L F
 750lm/ft 100% ↓ 0 7 5 0 L F
 1000lm/ft 100% ↓ 1 0 0 0 L F
 Custom lm/ft X X X X L F
 custom lumen up to 1200 lm/ft

K OUTPUT LM/FT UP

500lm/ft ↑ 0 5 0 0 L F
 750lm/ft ↑ 0 7 5 0 L F
 1000lm/ft ↑ 1 0 0 0 L F
 Custom lm/ft X X X X L F
 custom lumen up to 1000 lm/ft

K CIRCUIT / EM

Single circuit *
 EMC night light circuit N L C
 EMB available in 4ft and 8ft E M #
 Dual Circuit D C
 * leave blank

L SHAPE / PATTERN

Linear / straight S T
 Linear / straight + flex inset S F
 includes 1ft. field-cutttable section; only available for 4' and 8' segments
 L-shape L S
 □-shape (rectangular shape) R S
 U-shape U S
 Custom shape X X

M DIMENSIONS IN INCH

Linear 4' 4 8 I N
 Linear 6' 7 2 I N
 Linear 8' 9 6 I N
 Linear custom # # # I N
 Linear flex inset # # # I N
 includes 4' to 3' field-cutttable section
 L-Shape # # # X # # # I N
 U-Shape # # # X # # # X # # # I N
 □-Shape # # # X # # # I N



for curved options, please see our SHAPES brochure

for lengths including flex insets, round up to the nearest total foot length

N CERTIFICATION (optional)

Red List Approved D R L A

Technical data

	SIZE TYPE	LED COLOR TEMPERATURE	INPUT WATTS	DELIVERED LM TOTAL	LIGHT DISTRIBUTION	DELIVERED LM DIRECT	DELIVERED LM INDIRECT	OPTICAL EFFICIENCY	LUMINAIRE EFFICACY
BASO DIRECT / INDIRECT									
e LED 	4' linear	40K	16.4 W	1820lm	40% down / 60% up	188lm/ft	270 lm/ft	72%	111lm/W
	8' linear		32.8 W	3650lm					
	2' + 2' corner		16.4 W	1820lm					
e ² LED 	4' linear	40K	26.8 W	3020lm	40% down / 60% up	312lm/ft	445 lm/ft	72%	112lm/W
	8' linear		53.5 W	6040lm					
	2' + 2' corner		26.8 W	3020lm					

for 30K or 35K multiply lm value by 0.96

Patterns top view

LINEAR

A	FIXTURES	CODE
48"	1 x 4' linear	ST - 0 4 FT
96"	1 x 8' linear	ST - 0 8 FT
144"	3 x 4' linear	ST - 1 2 FT



L-SHAPE

A / B	FIXTURES	CODE
48" / 48"	2 x 2' linear + 1 x 2' x 2' corner	LS - 0 4 X 0 4 FT
48" / 96"	1 x 2' linear + 1 x 6' linear + 1 x 2' x 2' corner	LS - 0 4 X 0 8 FT
96" / 96"	2 x 6' linear + 1 x 2' x 2' corner	LS - 0 8 X 0 8 FT

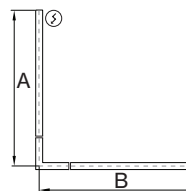

□-SHAPE (rectangular shape)

A / B	FIXTURES	CODE
48" / 48"	4 x 2' x 2' corner	RS - 0 4 X 0 4 FT
48" / 96"	2 x 4' linear + 4 x 2' x 2' corner	RS - 0 4 X 0 8 FT
96" / 96"	4 x 4' linear + 4 x 2' x 2' corner	RS - 0 8 X 0 8 FT

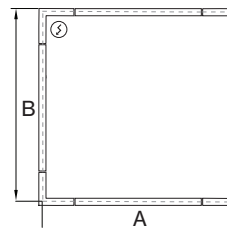

U-SHAPE

A / B / C	FIXTURES	CODE
48" / 48" / 48"	2 x 2' linear + 2 x 2' x 2' corner	US - 0 4 X 0 4 X 0 4 FT
48" / 96" / 48"	1 x 4' linear + 2 x 2' linear + 2 x 2' x 2' corner	US - 0 4 X 0 8 X 0 4 FT
48" / 144" / 48"	1 x 8' linear + 2 x 2' linear + 2 x 2' x 2' corner	US - 0 4 X 1 2 X 0 4 FT

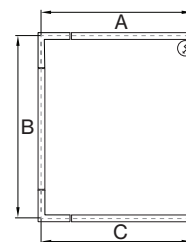

DIMENSIONS

BASO 2.5

PENDANT

direct direct / indirect

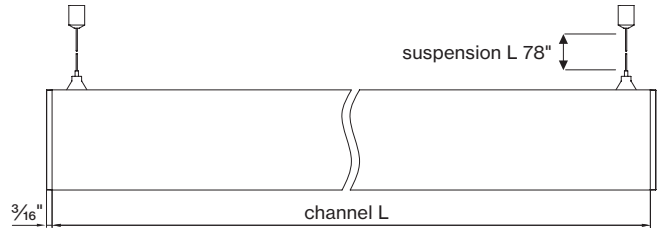
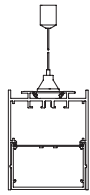
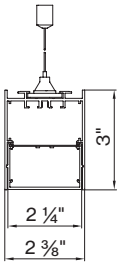

BASO 2.5 SPECIALITY MOUNTING

SURFACE
in-line ACT TBAR

SURFACE
in-line ACT SLOT

SURFACE
ACT center tile

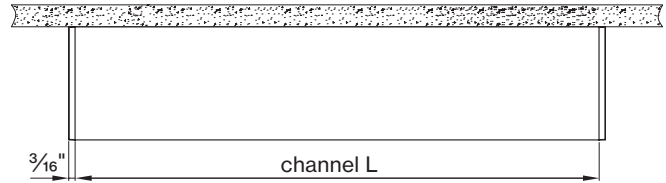
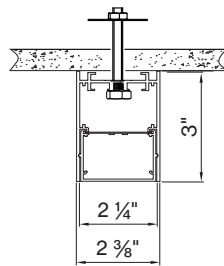
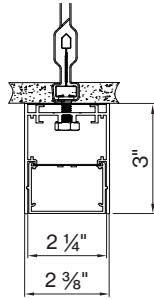
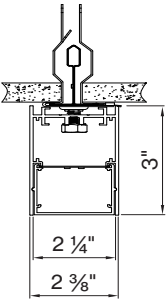

PENDANT
ACT TBAR

PENDANT
in-line ACT SLOT

PENDANT
ACT center tile

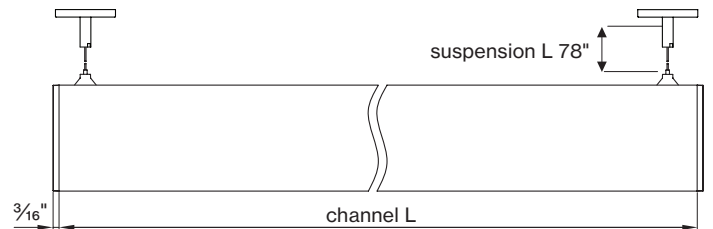
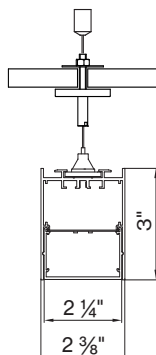
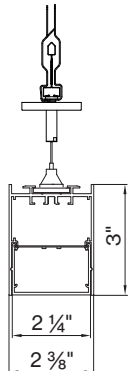
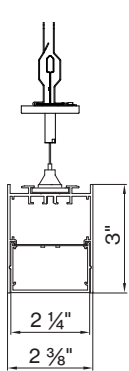

Declare.

BASO 1.5 2.5 4.0
BASO Inc.

Final Assembly: Collins, Connecticut, USA
LULU (Manufacturing) Thailand
End of Life Options: Recyclable (80%), Landfill (20%)

Ingredients

Aluminum, 2-Propenoic acid, 2-methyl-, methyl ester, polymer with styrene, 3-comonomers, Steel, manufactory, chemical, Copper channel, Cu-35, Steel, manufactory, component, Polyethylene, Glass, 10-, Titanium Dioxide (G-Nano), Copper, Stainless Steel, Tin, Organic Silicon

ULC Temp Exception RECO2 - Small Electrical Components

Living Building Challenge Criteria Compliant

LEED Gold List
LEED Red List Free LEED 100% at 100ppm
LEED Red List Approved VOC Content: Not Applicable
Cradled
LEED Interior Performance: Not Applicable
LEED Responsible Sourcing: Not Applicable

BASO-0002
REV 01/02/2025
Original Issue Date: 2023

INTERNATIONAL LIVING FUTURE MATERIALS™ Living Building Challenge

BASO mounting instructions

Get access to the BASO 2.5 mounting instructions faster by scanning the QR code.

<https://www.basolighting.com/resources/mounting-instructions/baso>

