

BASO 2.5

DIRECT/INDIRECT

Catalog Number Example

BASO 2.5-PDT-BL-OPBW-27K-C80-UNV-010V-0500LF-0500LF-DC-ST-48IN

A B C D E F G H J K L M N

CERTIFICATIONS & COMPLIANCE



FEATURES



PERFORMANCE

- Up to 112lm/W efficiency
- 455 / 750lm/ft
- CRI > 80 & CRI > 90
- Damp rated

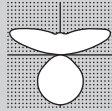

MOUNTING

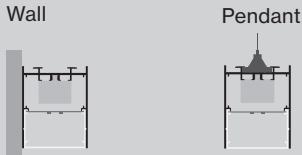

PATTERNS

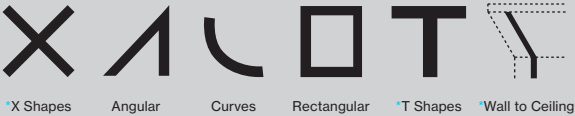

For customization, please contact customer service

FIELD-CUTTABLE FLEX

Down to 1/16"



[link to video](#)

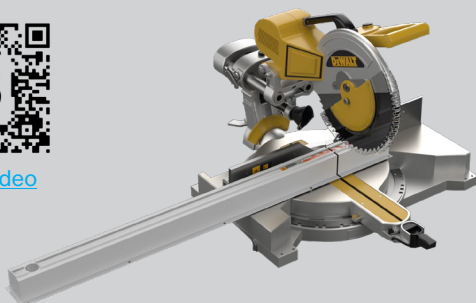

A RANGE

BASO 2.5 BASO 2.5

B MOUNTING

Pendant P D T
 Pendant in-line ACT T-BAR P A T
 Pendant in-line ACT SLOT P A S
 Pendant ACT center tile P A C
 pendant suspension set includes cable suspension and one white power feeder with a white junction box cover
 Wall mounted W A L

for black power feeds or junction box covers, please contact customer service

C COLOR

White W H
 Black B L
 Gray G R
 Custom color RAL X X

trimless version available in white only

D LENS

HP opal cover direct O P B W
 batwing cover indirect

E CCT

2700K 2 7 K
 3000K 3 0 K
 3500K 3 5 K
 4000K 4 0 K

F CRI

CRI > 80 C 8 0
 CRI > 90 C 9 0

G VOLTAGE

120V / 277V U N V

H DIMMING

0-10V 1% 0 1 0 V
 Lutron EcoSystem L E S 1
 Quantum, Vive, GRAFIK Eye, HomeWorks
 Power over ethernet P O E C
 consult customer service for compatibility
 Custom dimming X X X X
 consult customer service for compatibility

I SENSOR (optional)

Integrated Sensor S E N
 consult customer service for sensor request

J OUTPUT LM/FT DOWN

500lm/ft 100% 0 5 0 0 L F
 750lm/ft 100% 0 7 5 0 L F
 1000lm/ft 100% 1 0 0 0 L F
 Custom lm/ft X X X X L F
 custom lumen up to 1200 lm/ft

K OUTPUT LM/FT UP

500lm/ft 0 5 0 0 L F
 750lm/ft 0 7 5 0 L F
 1000lm/ft 1 0 0 0 L F
 Custom lm/ft X X X X L F
 custom lumen up to 1000 lm/ft

K CIRCUIT / EM

Single circuit *
 EMC night light circuit N L C
 EMB available in 4ft and 8ft E M #
 Dual Circuit D C
 * leave blank

L SHAPE / PATTERN

Linear / straight S T
 Linear / straight + flex inset S F
 includes 1ft. field-cutttable section; only available for 4' and 8' segments
 L-shape L S
 □-shape (rectangular shape) R S
 U-shape U S
 Custom shape X X

M DIMENSIONS IN INCH

Linear 4' 4 8 I N
 Linear 6' 7 2 I N
 Linear 8' 9 6 I N
 Linear custom ### I N
 Linear flex inset ### I N
 includes 4' to 3' field-cutttable section
 L-Shape ### X ### I N
 U-Shape ### X ### X ### I N
 □-Shape ### X ### I N

for curved options, please see our SHAPES brochure

for lengths including flex insets, round up to the nearest total foot length

N CERTIFICATION (optional)

Red List Approved D R L A

Technical data

BASO 2.5 DIRECT

Delivered Lumens	CCT	CRI	Input Watts	Luminaire Efficacy
500 lm/ft ↓	4000K	CRI > 80	4.1 W/ft	122 lm/W
750 lm/ft ↓	4000K	CRI > 80	6.3 W/ft	119 lm/W
1000 lm/ft ↓	4000K	CRI > 80	8.9 W/ft	112 lm/W

LUMEN OUTPUT MULTIPLIER*

Color Temperature	CRI	
	80+	90+
4000K	1	0.86
3500K	0.96	0.84
3000K	0.95	0.82
2700K	0.91	0.78

BASO UPLIGHT

Delivered Lumens	CCT	CRI	Input Watts	Luminaire Efficacy
400 lm/ft †	4000K	CRI > 80	3.5 W/ft	114 lm/W
500 lm/ft †	4000K	CRI > 80	4.3 W/ft	116 lm/W
600 lm/ft †	4000K	CRI > 80	5.2 W/ft	115 lm/W
750 lm/ft †	4000K	CRI > 80	6.9 W/ft	109 lm/W
800 lm/ft †	4000K	CRI > 80	6.9 W/ft	108 lm/W
1000 lm/ft †	4000K	CRI > 80	9.4 W/ft	106 lm/W

Patterns top view

LINEAR

A	FIXTURES	CODE
48"	1 × 4' linear	ST - 0 4 FT
96"	1 × 8' linear	ST - 0 8 FT
144"	3 × 4' linear	ST - 1 2 FT



L-SHAPE

A / B	FIXTURES	CODE
48" / 48"	2 × 2' linear + 1 × 2' × 2' corner	LS - 0 4 X 0 4 FT
48" / 96"	1 × 2' linear + 1 × 6' linear + 1 × 2' × 2' corner	LS - 0 4 X 0 8 FT
96" / 96"	2 × 6' linear + 1 × 2' × 2' corner	LS - 0 8 X 0 8 FT

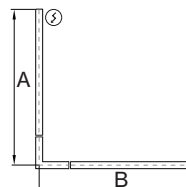

□-SHAPE (rectangular shape)

A / B	FIXTURES	CODE
48" / 48"	4 × 2' × 2' corner	RS - 0 4 X 0 4 FT
48" / 96"	2 × 4' linear + 4 × 2' × 2' corner	RS - 0 4 X 0 8 FT
96" / 96"	4 × 4' linear + 4 × 2' × 2' corner	RS - 0 8 X 0 8 FT

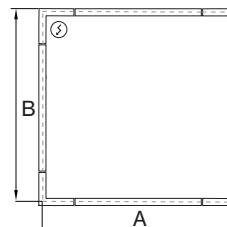

U-SHAPE

A / B / C	FIXTURES	CODE
48" / 48" / 48"	2 × 2' linear + 2 × 2' × 2' corner	US - 0 4 X 0 4 X 0 4 FT
48" / 96" / 48"	1 × 4' linear + 2 × 2' linear + 2 × 2' × 2' corner	US - 0 4 X 0 8 X 0 4 FT
48" / 144" / 48"	1 × 8' linear + 2 × 2' linear + 2 × 2' × 2' corner	US - 0 4 X 1 2 X 0 4 FT

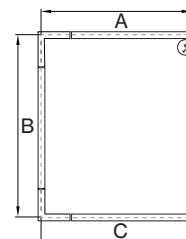

DIMENSIONS

BASO 2.5

PENDANT

direct

direct / indirect

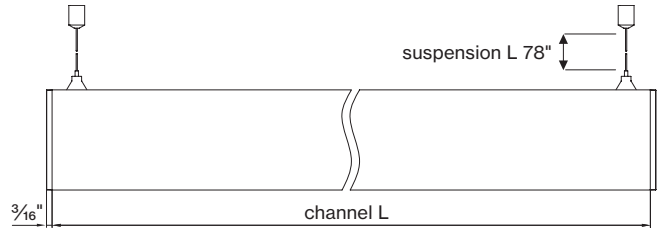
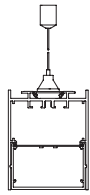
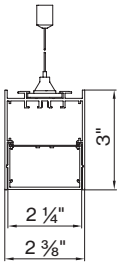

BASO 2.5 SPECIALITY MOUNTING

SURFACE
in-line ACT TBAR

SURFACE
in-line ACT SLOT

SURFACE
ACT center tile

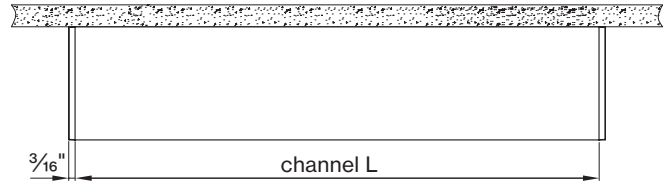
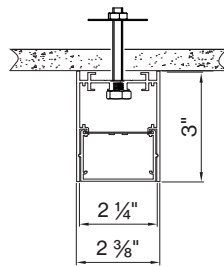
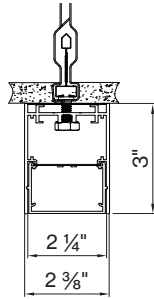
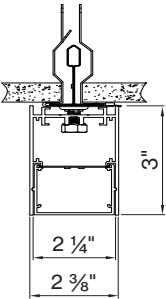

PENDANT
ACT TBAR

PENDANT
in-line ACT SLOT

PENDANT
ACT center tile

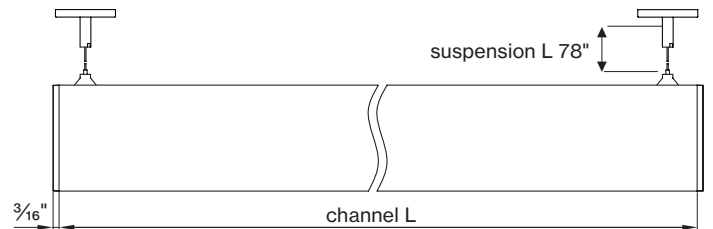
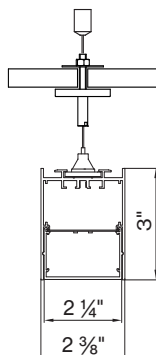
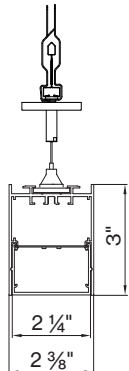
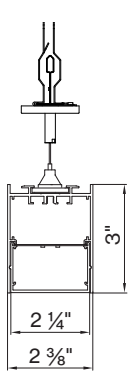

Declare.

BASO 1.5 2.5 4.0
BASO Inc.

Final Assembly: Collins, Connecticut, USA
LULU (Manufacturing: Taiwan)
End of Life Options: Recyclable (80%), Landfill (20%)

Ingredients

Aluminum, 2-Phenylacetic acid, 2-methyl-, methyl ester, polymer with ethyl 2-cyanoacrylate, Steel, manufacture, Chemicals, Copper channel, Cu2O, Steel, mounting components, Polyethylene, Glass, LED, Infrared/ultraviolet, Infrared/ultraviolet, Copper, Stainless Steel, Tin, Organic Silicon

ULC Temp Exception RECOG - Small Electrical Components

Living Building Challenge Criteria Compliant

H1 Red List: U.S. Green Building Council (USGBC) GreenGuard Gold VOC Content: Not Applicable

H2 Interior Performance: Not Applicable

H3 Responsible Sourcing: Not Applicable

BASO-0002

ISSUE DATE: 2023

Original Issue Date: 2023

INTERNATIONAL LIVING FUTURE INITIATIVE™ www.livingfuture.com

BASO mounting instructions

Get access to the BASO 2.5 mounting instructions faster by scanning the QR code.

<https://www.basolighting.com/resources/mounting-instructions/baso>

