

BASO 1.5

DIRECT / INDIRECT



CERTIFICATIONS & COMPLIANCE



FEATURES



PERFORMANCE

- Up to 110lm/W efficiency
- 400 / 550lm/ft
- CRI > 80 & CRI > 90
- Damp rated

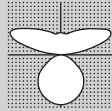

MOUNTING

Pendant



PATTERNS



*X Shapes Angular Curves Rectangular *T Shapes *Wall to Ceiling

For customization, please contact customer service

FIELD-CUTTABLE FLEX

Down to 1/16"



[link to video](#)

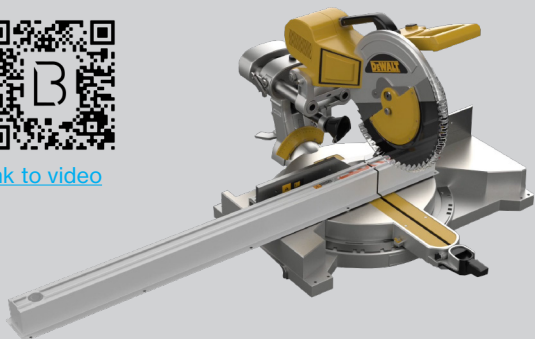

Catalog Number Example

BASO 1.5-PDT-BL-OPBW-27K-C80-UNV-010V-SEN-0400LF-0400LF-DC-ST-48IN

A B C D E F G H I J K L M N

A RANGE

BASO 1.5 BASO 1.5

B MOUNTING

CS Pendant P D T
 Pendant in-line ACT T-BAR P A T
 Pendant in-line ACT SLOT P A S
 Pendant ACT center tile P A C
 pendant suspension set includes cable suspension and one white power feeder with a white junction box cover
 Wall mounted W A L
 for black power feeds or junction box covers, please contact customer service

C COLOR

CS White W H
CS Black B L
 Gray G R
 Custom color RAL X X
 trimless version available in white only

D LENS

HP opal cover direct O P B W
 Batwing cover indirect

E CCT

2700K 2 7 K
CS 3000K 3 0 K
CS 3500K 3 5 K
 4000K 4 0 K

F CRI

CRI > 80 C 8 0
 CRI > 90 C 9 0

G VOLTAGE

120V / 277V U N V

H DIMMING

CS 0-10V 1% 0 1 0 V
 Lutron EcoSystem L E S 1
 Quantum, Vive, GRAFIK Eye,
 HomeWorks
 Power over ethernet P O E C
 consult customer service for compatibility
 Custom dimming X X X X
 consult customer service for compatibility

I SENSOR (optional)

Integrated Sensor S E N
 consult customer service for sensor request

J OUTPUT LM/FT DOWN

CS 400lm/ft ↓ 0 4 0 0 L F
CS 600lm/ft ↓ 0 6 0 0 L F
 800lm/ft ↓ 0 8 0 0 L F
 Custom lm/ft X X X X L F
 custom lumen up to 800 lm/ft

K OUTPUT LM/FT UP

CS 400lm/ft ↑ 0 4 0 0 L F
CS 600lm/ft ↑ 0 6 0 0 L F
CS 800lm/ft ↑ 0 8 0 0 L F
 Custom lm/ft X X X X L F
 custom lumen up to 1000 lm/ft

L CIRCUIT / EM

CS Single circuit *
 EMC night light circuit N L C
 EMB available in 4ft and 8ft E M #
 Dual Circuit D C
 * leave blank

M SHAPE / PATTERN

CS Linear / straight S T
CS Linear / straight + flex inset S F
 includes 1ft. field-cuttability section; only available for 4' and 8' segments
 L-shape L S
 □-shape (rectangular shape) R S
 U-shape U S
 Custom shape X X
 for grid applications using L-shape, rectangular shape or U-shape, please contact customer service for availability

N DIMENSIONS IN INCH



CS Linear 4' 4 8 I N
CS Linear 6' 7 2 I N
CS Linear 8' 9 6 I N
 Linear custom # # # I N
 Linear flex inset # # # I N
 includes 4' to 3' field-cuttability section
 L-Shape # # # X # # # I N
 U-Shape # # # X # # # X # # # I N
 □-Shape # # # X # # # I N

for lengths including flex insets, round up to the nearest total foot length

O CERTIFICATION (optional)

Red List Approved R L A

Technical data

	SIZE TYPE	LED COLOR TEMPERATURE	INPUT WATTS	DELIVERED LM TOTAL	LIGHT DISTRIBUTION	DELIVERED LM DIRECT	DELIVERED LM INDIRECT	OPTICAL EFFICIENCY	LUMINAIRE EFFICACY
BASO DIRECT / INDIRECT									
e LED 	4' linear	40K	15.2W	1650lm	40% down / 60% up	157 lm/ft	253 lm/ft	70%	108 lm/W
	8' linear		30.5W	3300lm					
	2' + 2' corner		15.2W	1650lm					
e ² LED 	4' linear	40K	20.2W	2230lm	40% down / 60% up	215 lm/ft	343 lm/ft	70%	110 lm/W
	8' linear	30K, 35K	40.4W	4470lm					
	2' + 2' corner	40K	20.2W	2230lm					

for 30K or 35K multiply lm value by 0.96

Patterns top view

LINEAR

A	FIXTURES	CODE
48"	1 x 4' linear	ST - 0 4 FT
96"	1 x 8' linear	ST - 0 8 FT
144"	3 x 4' linear	ST - 1 2 FT



L-SHAPE

A / B	FIXTURES	CODE
48" / 48"	2 x 2' linear + 1 x 2' x 2' corner	LS - 0 4 X 0 4 FT
48" / 96"	1 x 2' linear + 1 x 6' linear + 1 x 2' x 2' corner	LS - 0 4 X 0 8 FT
96" / 96"	2 x 6' linear + 1 x 2' x 2' corner	LS - 0 8 X 0 8 FT

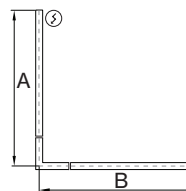

□-SHAPE (rectangular shape)

A / B	FIXTURES	CODE
48" / 48"	4 x 2' x 2' corner	RS - 0 4 X 0 4 FT
48" / 96"	2 x 4' linear + 4 x 2' x 2' corner	RS - 0 4 X 0 8 FT
96" / 96"	4 x 4' linear + 4 x 2' x 2' corner	RS - 0 8 X 0 8 FT

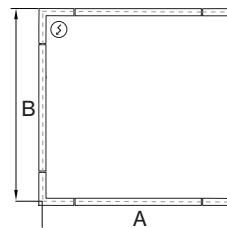

U-SHAPE

A / B / C	FIXTURES	CODE
48" / 48" / 48"	2 x 2' linear + 2 x 2' x 2' corner	US - 0 4 X 0 4 X 0 4 FT
48" / 96" / 48"	1 x 4' linear + 2 x 2' linear + 2 x 2' x 2' corner	US - 0 4 X 0 8 X 0 4 FT
48" / 144" / 48"	1 x 8' linear + 2 x 2' linear + 2 x 2' x 2' corner	US - 0 4 X 1 2 X 0 4 FT

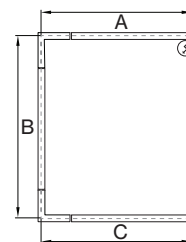

DIMENSIONS

BASO 1.5

PENDANT
direct

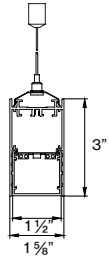

direct / indirect

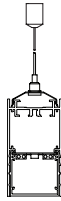

linear 4ft / 8ft

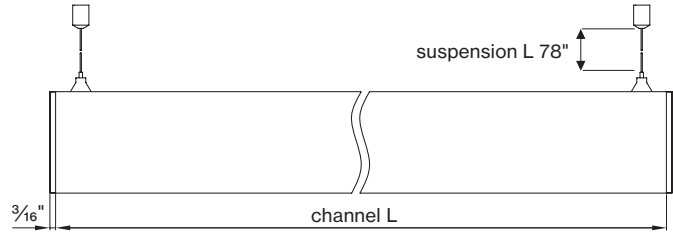

BASO 1.5 SPECIALITY MOUNTING

SURFACE
in-line ACT TBAR

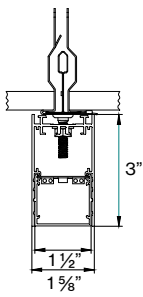

SURFACE
in-line ACT SLOT

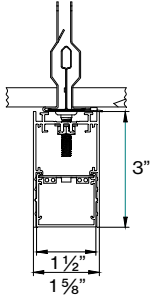

SURFACE
ACT center tile

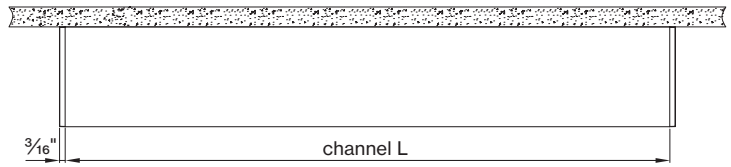
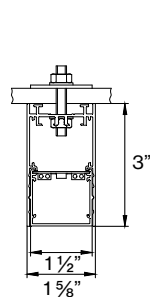

PENDANT
ACT TBAR

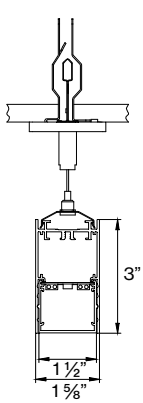

PENDANT
in-line ACT SLOT

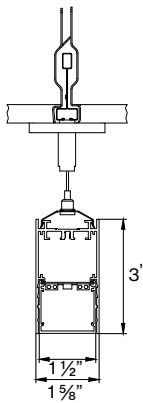

PENDANT
ACT center tile

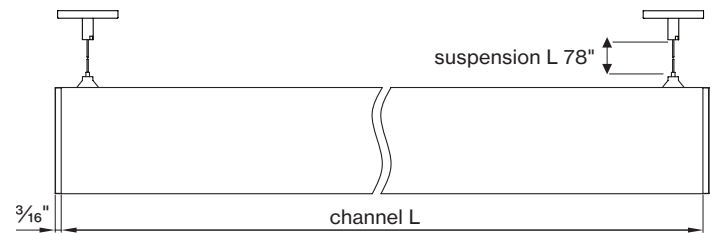
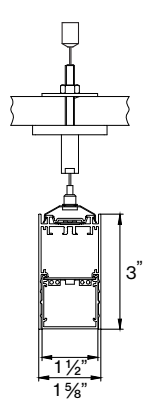

BASO mounting instructions

Get access to the BASO 1.5 mounting instructions faster by scanning the QR code.

<https://www.basolighting.com/resources/mounting-instructions/baso>

