

BASO 1.5 DIRECT



CERTIFICATIONS & COMPLIANCE



FEATURES



PERFORMANCE

- Up to 98lm/W efficiency
- 400 / 800lm/ft
- CRI > 80 & CRI > 90
- Damp rated

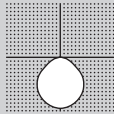

MOUNTING

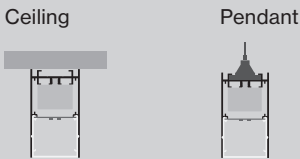

PATTERNS



*X Shapes Angular Curves Rectangular *T Shapes *Wall to Ceiling

For customization, please contact customer service

FIELD-CUTTABLE FLEX

Down to 1/16"



[link to video](#)

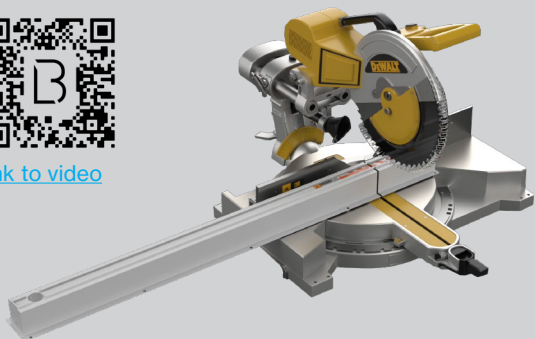

Catalog Number Example

BASO 1.5-SUR-BL-OP-27K-C80-UNV-010V-0400LF-NLC-ST-24IN

A B C D E F G H J K L M

A RANGE

BASO 1.5 B A S O 1 . 5

B MOUNTING

QS Surface	SUR
Surface in-line ACT T-BAR	SAT
Surface in-line ACT SLOT	SAS
Surface ACT center tile	SAC
QS Pendant	PDT
Pendant in-line ACT T-BAR	PAT
Pendant in-line ACT SLOT	PAS
Pendant ACT center tile	PAC

pendant suspension set includes cable suspension and one white power feeder with a white junction box cover

Wall mounted W A L

for black power feeds or junction box covers, please contact customer service

C COLOR

QS White	W H
QS Black	B L
Gray	G R
Custom color RAL	X X

D LENS

HP opal cover O P

E CCT

2700K	2 7 K
QS 3000K	3 0 K
QS 3500K	3 5 K
4000K	4 0 K

F CRI

CRI > 80	C 8 0
CRI > 90	C 9 0

G VOLTAGE

120V / 277V U N V

H DIMMING

QS 0-10V 1%	0 1 0 V
Lutron EcoSystem	L E S 1
Quantum, Vive, GRAFIK Eye, HomeWorks	
Power over ethernet	P O E C
consult customer service for compatibility	
Custom dimming	X X X X
consult customer service for compatibility	

I SENSOR (optional)

Integrated Sensor S E N
consult customer service for sensor request

J OUTPUT LM/FT

QS 400lm/ft 100% ±	0 4 0 0 L F
QS 600lm/ft 100% ±	0 6 0 0 L F
QS 800lm/ft 100% ±	0 8 0 0 L F
Custom lm/ft	X X X X L F

custom lumen up to 1000 lm/ft

K CIRCUIT / EM

QS Single circuit	*
EMC night light circuit	N L C
EMB available in 4ft and 8ft	E M #

*leave blank

L SHAPE / PATTERN

QS Linear / straight	S T
QS Linear / straight + flex inset	S F
includes 1ft. field-cuttable section; only available for 4' and 8' segments	
L-shape	L S
□-shape (rectangular shape)	R S
U-shape	U S
Custom shape	X X

M DIMENSIONS IN INCH



Linear 2'	2 4 I N
QS Linear 4'	4 8 I N
QS Linear 6'	7 2 I N
QS Linear 8'	9 6 I N
Linear custom	## # I N
Linear flex inset	## # I N
field-cuttable section	
L-Shape	## # X ## # I N
U-Shape	## # X ## # X ## # I N
□-Shape	## # X ## # I N

for lengths including flex insets, round up to the nearest **total** foot length

N CERTIFICATION (optional)

Red List Approved R L A

Technical data

	SIZE TYPE	LED COLOR TEMPERATURE	INPUT WATTS	DELIVERED LM TOTAL	LIGHT DISTRIBUTION	DELIVERED LM DIRECT	DELIVERED LM INDIRECT	OPTICAL EFFICIENCY	LUMINAIRE EFFICACY	
BASO DIRECT										
	e LED	2' linear	40K	8.2W	800lm	100% down	400lm/ft	-	67%	98lm/W
		4' linear		16.4W	1610lm					
		8' linear		32.8W	3220lm					
		2' + 2' corner		16.4W	1610lm					
	e² LED	2' linear	40K	11.75W	1100lm	100% down	550lm/ft	-	67%	94lm/W
		4' linear		23.5W	2200lm					
		8' linear		47W	4410lm					
		2' + 2' corner		23.5W	2200lm					

for 30 K or 35 K multiply lm value by 0.96

Patterns top view

LINEAR

A	FIXTURES	CODE
48"	1 × 4' linear	ST - 0 4 F T
96"	1 × 8' linear	ST - 0 8 F T
144"	3 × 4' linear	ST - 1 2 F T



L-SHAPE

A / B	FIXTURES	CODE
48" / 48"	2 × 2' linear + 1 × 2' × 2' corner	LS - 0 4 X 0 4 F T
48" / 96"	1 × 2' linear + 1 × 6' linear + 1 × 2' × 2' corner	LS - 0 4 X 0 8 F T
96" / 96"	2 × 6' linear + 1 × 2' × 2' corner	LS - 0 8 X 0 8 F T

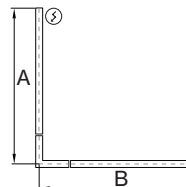

□-SHAPE (rectangular shape)

A / B	FIXTURES	CODE
48" / 48"	4 × 2' × 2' corner	RS - 0 4 X 0 4 F T
48" / 96"	2 × 4' linear + 4 × 2' × 2' corner	RS - 0 4 X 0 8 F T
96" / 96"	4 × 4' linear + 4 × 2' × 2' corner	RS - 0 8 X 0 8 F T

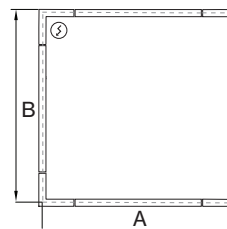

U-SHAPE

A / B / C	FIXTURES	CODE
48" / 48" / 48"	2 × 2' linear + 2 × 2' × 2' corner	US - 0 4 X 0 4 X 0 4 F T
48" / 96" / 48"	1 × 4' linear + 2 × 2' linear + 2 × 2' × 2' corner	US - 0 4 X 0 8 X 0 4 F T
48" / 144" / 48"	1 × 8' linear + 2 × 2' linear + 2 × 2' × 2' corner	US - 0 4 X 1 2 X 0 4 F T

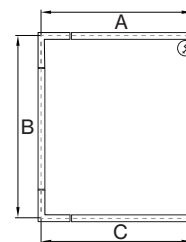

DIMENSIONS

BASO 1.5

SURFACE
direct

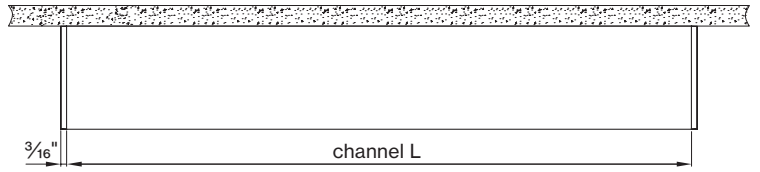
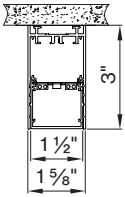

PENDANT
direct

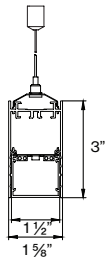

direct / indirect

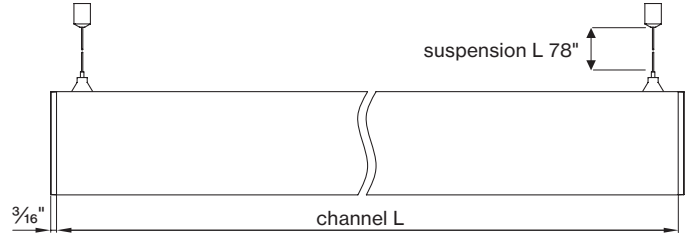
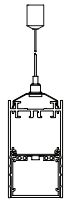

BASO 1.5 SPECIALITY MOUNTING

SURFACE
in-line ACT TBAR

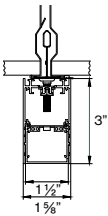

SURFACE
in-line ACT SLOT

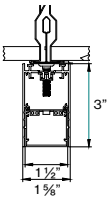

SURFACE
ACT center tile

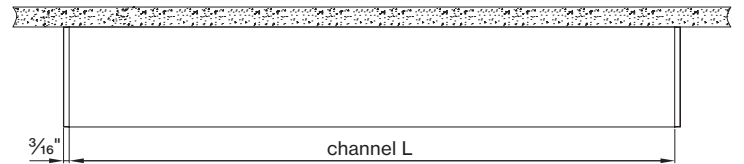
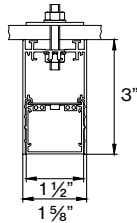

PENDANT
ACT TBAR

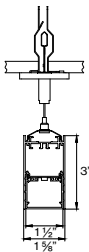

PENDANT
in-line ACT SLOT

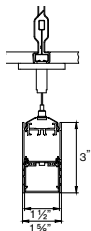

PENDANT
ACT center tile

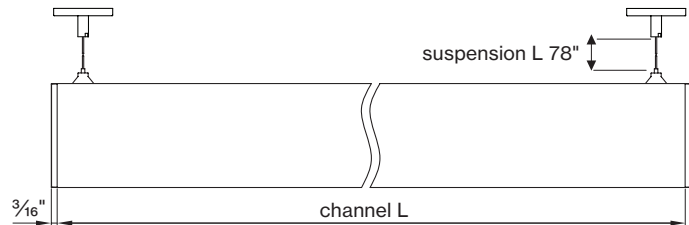
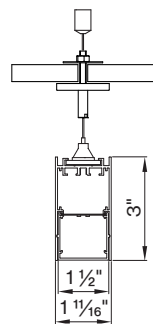

BASO mounting instructions

Get access to the BASO 1.5 mounting instructions faster by scanning the QR code.

<https://www.basolighting.com/resources/mounting-instructions/baso>

